

Article number: 04H061500500250

Description: Stabilus IndustryLine gas spring size 06/15
250N length 132mm, stroke 50mm Type 04H0615250

Measures

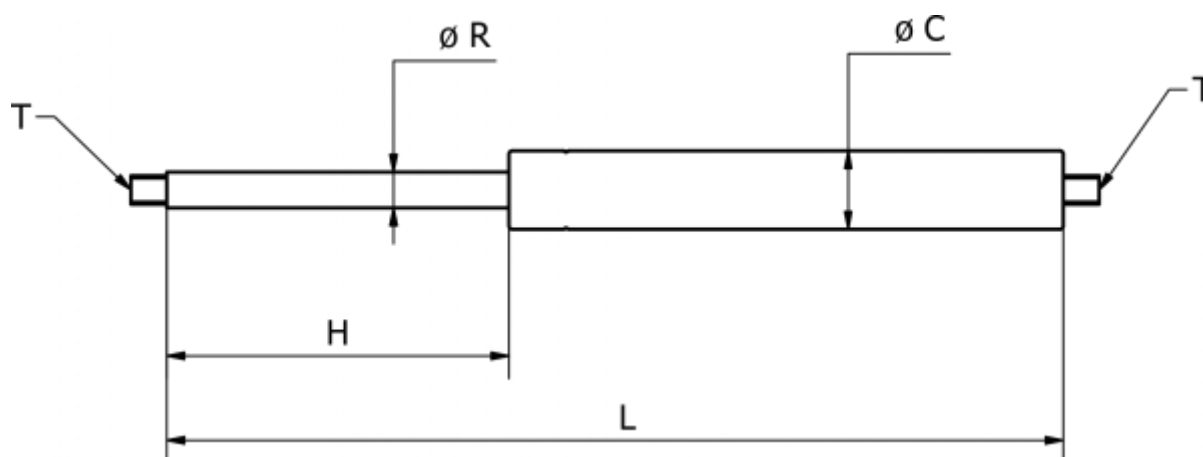

C = 15
H = 50
L = 132
R = 6
T = M5 x 5